

HTEM – Tubo con manguito (push-fit)

Ref. Nº	DN	Longitud [mm]	Paquetería
10100	40	150	20/960
10110	40	250	20/960
10120	40	500	20/320
10140	40	1.000	10/260
10160	40	2.000	10/260
10165	40	3.000	10/260
10200	50	150	20/720
10210	50	250	20/720
10220	50	500	20/320
10240	50	1.000	10/200
10260	50	2.000	10/200
10265	50	3.000	10/200
10300	75	150	20/480
10310	75	250	20/320
10320	75	500	20/160
10340	75	1.000	6/120
10360	75	2.000	6/120
10365	75	3.000	6/120
10368	90	150	20/320
10370	90	250	20/240
10375	90	500	10/120
10385	90	1.000	4/96
10390	90	2.000	4/96
10395	90	3.000	4/96
10400	110	150	20/160
10410	110	250	20/160
10420	110	500	10/80
10440	110	1.000	4/60
10460	110	2.000	4/60
10465	110	3.000	4/60
10500	125	150	10/120
10510	125	250	10/120
10520	125	500	5/60
10540	125	1.000	1/54
10560	125	2.000	1/54
10565	125	3.000	1/54
10600	160	150	1/84
10610	160	250	1/56
10620	160	500	1/35
10640	160	1.000	1/35
10660	160	2.000	1/35
10665	160	3.000	1/35

Tubería HT

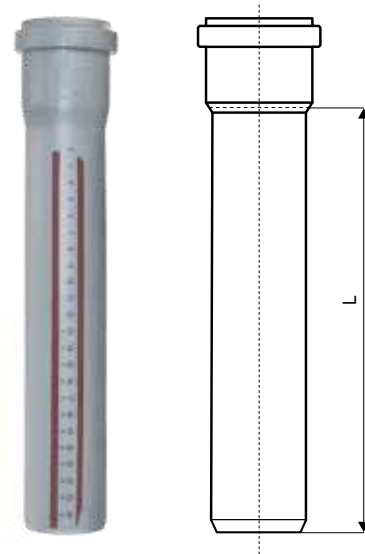

Accesorios HT

HTB – Codo

Ref. Nº	DN	α	z_1	z_2	l_1	Paquetería
10700	40	15°	5	9	44	20/960
10800	50	15°	5	9	46	20/960
10900	75	15°	7	11	51	20/480
10905	90	15°	6	12	54	20/480
11000	110	15°	9	17	58	20/240
11100	125	15°	10	17	64	20/160
11200	160	15°	13	22	73	10/80

Ref. Nº	DN	α	z_1	z_2	l_1	Paquetería
10710	40	30°	7	11	44	20/960
10810	50	30°	9	13	46	20/960
10910	75	30°	12	16	51	20/480
10915	90	30°	13	18	54	20/480
11010	110	30°	17	24	58	20/240
11110	125	30°	19	25	64	20/160
11210	160	30°	24	32	73	10/80

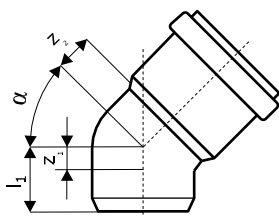

Ref. Nº	DN	α	z_1	z_2	l_1	Paquetería
10720	40	45°	10	14	44	20/960
10820	50	45°	12	16	46	20/960
10920	75	45°	16	12	51	20/480
10925	90	45°	20	25	54	20/480
11020	110	45°	17	24	58	20/240
11120	125	45°	28	34	64	20/160
11220	160	45°	36	46	73	5/60



Ref. Nº	DN	α	z_1	z_2	l_1	Paquetería
10730	40	67°	16	20	44	20/960
10830	50	67°	22	23	46	20/960
10930	75	67°	28	31	51	20/480
10935	90	67°	32	36	54	20/240
11030	110	67°	40	44	58	20/160
11130	125	67°	40	44	58	20/120

Ref. Nº	DN	α	z_1	z_2	l_1	Paquetería
10750	40	87°	23	26	42	20/960
10850	50	87°	28	31	46	20/960
10950	75	87°	40	43	51	20/480
10955	90	87°	46	49	54	20/240
11050	110	87°	57	61	58	20/160
11150	125	87°	65	71	64	10/120
11250	160	87°	83	96	73	5/60

HTEA – Derivación

Ref. Nº	DN	α	z_1	z_2	z_3	L [mm]	Paquetería
11500	40/40	45°	10	50	50	104	20/960
11510	50/40	45°	5	57	55	106	20/480
11520	50/50	45°	12	62	62	125	20/480
11540	75/50	45°	1	79	74	128	20/400
11550	75/75	45°	18	92	92	164	20/240
11552	90/50	45°	9	90	82	127	20/240
11554	90/75	45°	9	103	100	163	20/240
11556	90/90	45°	20	110	110	184	20/160
11560	110/50	45°	17	104	94	152	20/240
11570	110/75	45°	1	120	115	175	20/160
11580	110/110	45°	25	135	135	218	10/80
11590	125/110	45°	18	144	142	224	5/60
11600	125/125	45°	28	152	152	249	5/60
11610	160/110	45°	1	228	158	242	5/40
11630	160/160	45°	36	194	194	309	5/30

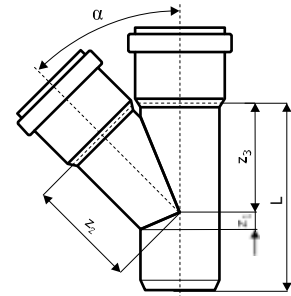

Ref. Nº	DN	α	z_1	z_2	z_3	L [mm]	Paquetería
11700	40/40	67°	16	33	33	99	20/960
11710	50/40	67°	14	39	35	95	20/480
11720	50/50	67°	20	41	41	110	20/480
11740	75/50	67°	14	54	46	115	20/480
11750	75/75	67°	28	66	60	143	20/240
11760	110/50	67°	8	73	54	125	20/240
11770	110/75	67°	22	78	68	148	20/160
11780	110/110	67°	40	88	88	186	10/120



Ref. Nº	DN	α	z_1	z_2	z_3	L [mm]	Paquetería
11900	40/40	87°	23	25	25	92	20/960
11910	50/40	87°	23	30	25	94	20/480
11920	50/50	87°	28	30	30	109	20/480
11940	75/50	87°	27	43	31	112	20/400
11950	75/75	87°	40	43	43	138	20/240
11952	90/50	87°	26	50	31	111	20/240
11954	90/75	87°	39	51	44	137	20/240
11956	90/90	87°	56	70	51	161	20/160
11960	110/50	87°	28	60	34	120	20/240
11970	110/75	87°	40	60	46	113	20/160
11980	110/110	87°	57	64	64	183	10/120
11990	125/110	87°	58	70	64	191	5/60
12000	125/125	87°	65	71	71	205	5/60
12010	160/110	87°	66	87	64	219	5/60
12030	160/160	87°	83	91	91	253	4/48

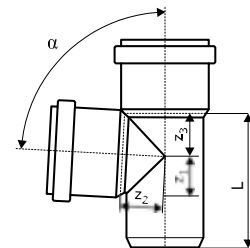

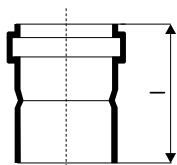

HTAM – Manguito corto

Ref. N°	DN	l [mm]	Paquetería
12700	40	113	20/1200
12710	50	116	20/480
12720	75	96,5	20/480
12730	110	123	20/240

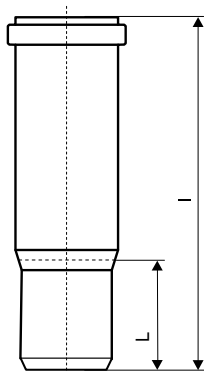

HTL – Manguito largo

Ref. N°	DN	l [mm]	L [mm]	Paquetería
12300	40	155	48	20/960
12310	50	211	54	20/480
12320	75	222	57	20/480
12325	90	151	60	20/240
12330	110	255	68	20/160

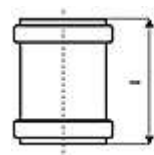

HTU – Manguito doble deslizante

Ref. N°	DN	l [mm]	Paquetería
12200	40	103	20/960
12210	50	105	20/960
12220	75	111	20/480
12225	90	98	20/480
12230	110	128	20/240
12240	125	120	20/160
12250	160	163	15/120

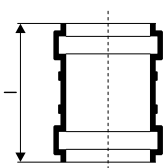

HTMM – Manguito doble

Ref. N°	DN	l [mm]	Paquetería
12100	40	103	20/960
12110	50	105	20/960
12120	75	111	20/480
12125	90	98	20/480
12130	110	128	20/240
12140	125	116	20/160
12150	160	163	15/120

HTDA – Derivación doble

Ref. N°	DN	α	z_1	z_2	z_3	L [mm]	Paquetería
11400	50/50/50	67°	20	41	41	107	20/480
11410	75/75/75	67°	28	55	55	138	20/240
11415	90/90/90	87°	46	51	51	151	20/160
11420	110/50/50	67°	8	73	73	121	10/120
11440	110/110/110	67°	40	87	87	189	5/60

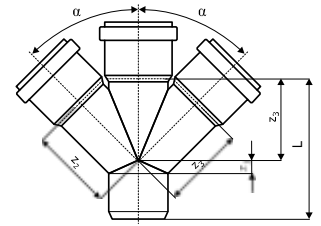

HTED – Derivación doble en esquina

Ref. N°	DN	α	z_1	z_2	z_3	L [mm]	Paquetería
11450	110/110/110	67°	40	86	86	148	10/80

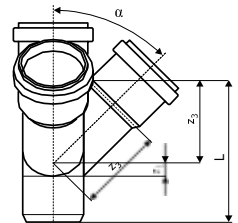

HTRE – Pieza de inspección

Ref. N°	DN	L [mm]	Paquetería
12410	50	110	20/480
12420	75	138	20/480
12425	90	171	20/240
12430	110	179	20/160
12440	125	191	5/60
12450	160	203	5/60

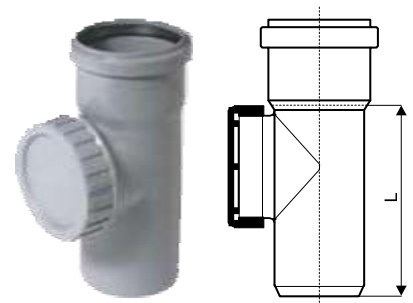

HTR – Reducción excéntrica

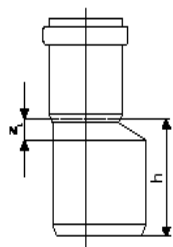

Ref. N°	DN	z	h [mm]	Paquetería
11300	50/40	12	64	20/960
11320	75/50	21	72	20/480
11325	90/50	29	83	20/480
11327	90/75	17	71	20/480
11330	110/50	40	102	20/480
11340	110/75	26	89	20/480
11345	110/90	17	75	20/240
11350	125/110	15	79	20/240
11360	160/110	38,5	118	20/160
11370	160/125	28	101	20/160

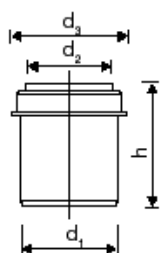

HT – Reducción corta

Ref. N°	DN	d_1	d_2	d_3	h [mm]	Paquetería
11375	50/40	50	41,2	59,5	61,5	20/1400

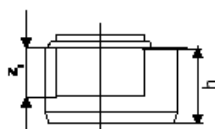

HTR – Reducción excéntrica, corta

Ref. N°	DN	z	h [mm]	Paquetería
11385	75/50	30,9	53	20/480
11390	110/50	30,5	58	20/480
11395	110/75	39,4	59	20/480

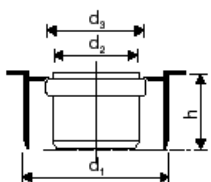

HTRI – Reducción interior

Ref. N°	DN	d_1	d_2	d_3	h [mm]	Paquetería
11397	110/50	90	50,8	60,3	44	20/960
11399	110/75	90	75,9	85,1	49,2	20/480

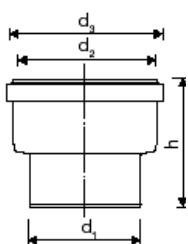

HT – Manguito de inserción

Ref. N°	DN	d_1	d_2	d_3	h [mm]	Paquetería
11460	110/110	90	111,5	126,7	108	20/240

HTM – Tapa

Ref. N°	DN	h [mm]	Paquetería
12500	40	33,5	20/2880
12510	50	34	20/2880
12520	75	39	20/2560
12525	90	39	20/960
12530	110	39	20/960
12540	125	43	20/480
12550	160	60	20/480

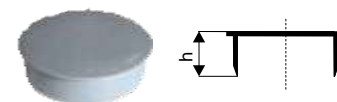

HTS – Conector a tubería hierro

Ref. N°	DN	d [mm]	l [mm]	L [mm]	Paquetería
12800	40/40	50	80	46	20/2880
12810	50/40	50	76	46	20/2880
12820	50/50	60	80	50	20/960

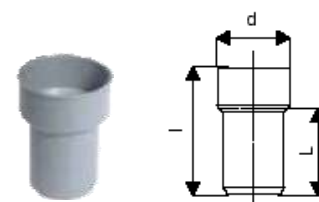

HTSW – Codo sifón

Ref. N°	DN	d ₁	z ₁	z ₂	L ₁	Paquetería
12850	40/30	40	24,5	22	75	20/960
12860	40/40	50	25	26	75,5	20/960
12840	50/30	47	23,5	23	86,4	1120/20
12870	50/40	50	30	32	81,5	20/960
12880	50/50	60	28	30	81	20/960

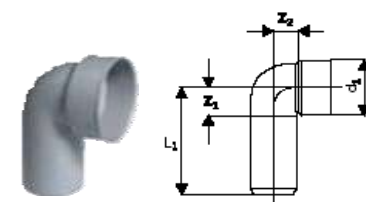

HTDSW – Codo doble sifón 90°

Ref. N°	DN	d ₁	z ₁	z ₂	L ₁	Paquetería
12890	40/50/40	50	28,5	33	76,5	20/480

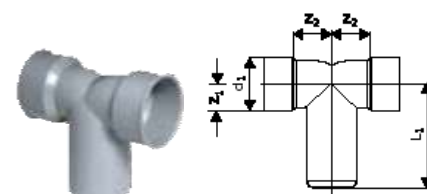

HTUG – Pieza de unión para tubería fundición

Ref. N°	DN	d ₆	l [mm]	L [mm]	Paquetería
12610	50	72	116	61	20/960
12620	75	92	118	57	20/480
12630	110	124	130	64	20/480

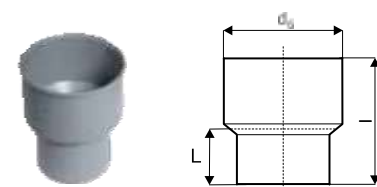

Complementos y soportes HT

HT – Junta de goma



Ref. Nº	DN	Paquetería
13040	40	33
13050	50	34
13060	75	34
13065	90	32
13070	110	39
13080	125	25
13090	160	31

HT – NBR Junta (resistente al aceite)



Ref. Nº	DN	Paquetería
13140	40	40
13150	50	34
13160	75	50
13165	90	32
13170	110	39
13180	125	38
13190	160	31

HT – Junta de goma para tubería de fundición



Ref. Nº	DN	Paquetería
13250	50	36/3024
13260	75	30/2520
13270	110	16/1344

HT – Repuesto para pieza de inspección



Ref. Nº	DN	Paquetería
13350	50	-
13360	75	-
13370	110	-

HTGM – Junta de goma para codo sifón

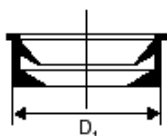

Ref. Nº	DN	D ₁	D ₂	Paquetería
12900	40/30 A	40	28-34	20
12910	40/30 B	50	28-34	20
12920	40/40 C	50	38-44	20
12935	40/50/1 1/4	47	28-34	20
12930	50/30 D	60	28-34	20
12940	50/40 E	60	38-44	20
12950	50/50 F	60	48-54	20

HT – Junta de goma para manguito corto

Ref. Nº	DN	Paquetería
13440	40	-
13450	50	-
13460	75	-
13470	110	-



Collarín intumescente “HV” HYDRAFIX

Ref. Nº	DN	Resistencia al Fuego	Paquetería
COL110	110	4 horas	28
COL125	125	4 horas	20
COL160	160	3 horas	12



Anclaje cuña HYDRAFIX

Ref. Nº	DN	Paquetería
ANC640	6 x 40	100



Multicollarín intumescente HYDRAFIX

Ref. Nº	Longitud mm.	Ancho mm.	Segmentos
MCOL	1.950	50	138



TABLA DE RESISTENCIA AL FUEGO / MEDIDA DE TUBERÍAS

Ø Tubería	Longitud del collarín	Nº horquillas	Resistencia al Fuego			
			EI-90 minutos	EI-120 minutos	EI-180 minutos	EI-240 minutos
90 mm	330 mm / 25 segmentos	3	1	1	1	1
110 mm	393 mm / 29 segmentos	3	1	1	1	1
125 mm	440 mm / 32 segmentos	3	1	1	1	-
160 mm	547 mm / 39 segmentos	4	1	2	2	-
200 mm	676 mm / 48 segmentos	5	2	2	2	-

HT – Lubricante

Ref. Nº	ml	Paquetería
13110	250	50/1500



Botes sifónicos



Bote sifónico en polipropileno

Ref. N°	DN	Altura mm	Paquetería
10.101	120	100	10
10.301	120	145	10

Bote formado por cuatro entradas de \varnothing 40 mm. y una salida de \varnothing 50 mm.



Tapa redonda inoxidable

Con rejilla + tapón

Ref. N°	DN	Altura mm	Paquetería
10.201	120	33	10

Tapa embellecedora en acero inoxidable con film protector



Tapa redonda inoxidable

Con rejilla + tapón completo

Con válvula antirretorno

Ref. N°	DN	Altura mm	Paquetería
10.401	120	75	10

Tapa embellecedora en acero inoxidable con film protector

Prolongador en PP

Ref. N°	DN	Altura mm	Paquetería
10.501	120	500	10



Junta para prolongador

Ref. N°	Altura mm	Paquetería
10.502	100	10